

Gabaritos das aulas

2 a 10

Aula 2

1. a) Cubo. b) Tronco de cilindro vazado. c) Esfera truncada.
2. a) 1 b) 5 c) 3 d) 2
3. b) X d) X
4. a) Cilindro. b) Tronco de cone. c) Esfera truncada.
5. Prisma de base trapezoidal ou tronco de prisma retangular.
6. (a)

Aula 3

1. b e e; a e d; c e f.
2. a) 3 b) 4 c) 1 d) 5 e) 2

Aula 4

1. a) 2 b) 3 c) 1 d) 5 e) 4
- 2.

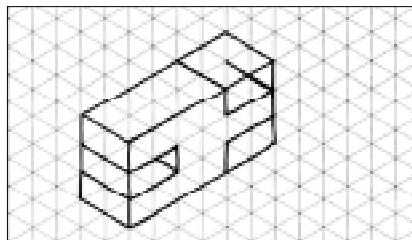

3. Seu desenho deve ter ficado igual ao modelo.

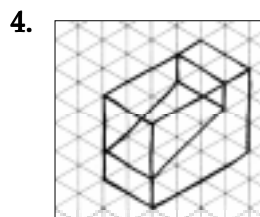

5. a) 4 b) 3 c) 2 d) 5 e) 1

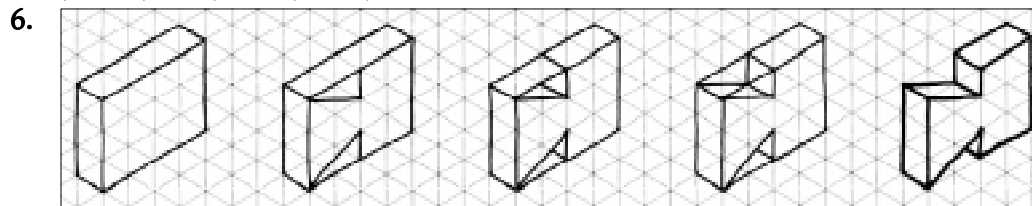

Aula 5

1. Elipse.
2. (c)
3. (3); (1); (5); (2); (4).
- 4.

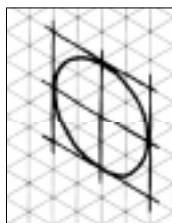

5.

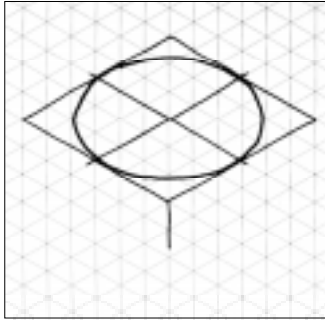

6. Círculo.

7. (5); (3); (4); (1); (2).

8. (d)

9.

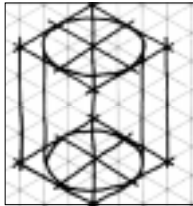

10. a) 4 b) 5 c) 1 d) 2 e) 3

11.

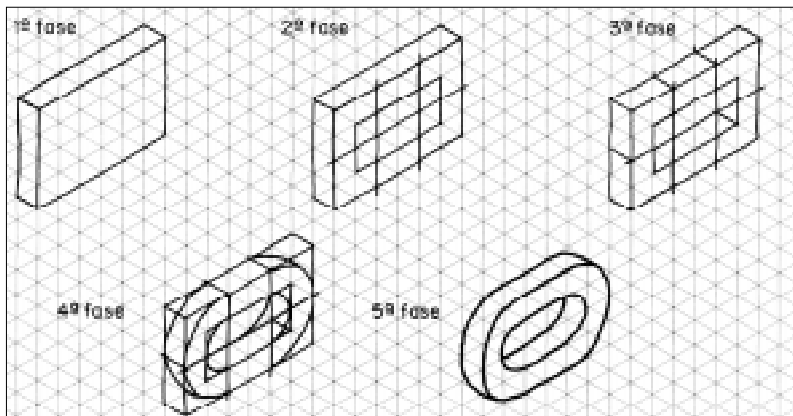

12. (b)

13. Seu desenho deve ter ficado igual ao modelo.

Aula 6

1. V

2.

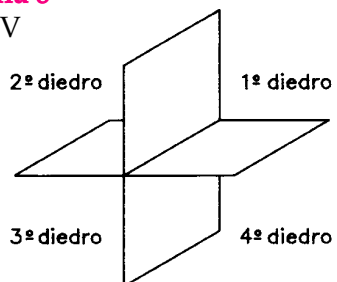

3. No Brasil, a ABNT recomenda a representação de desenhos técnicos no **1º diedro**.

4. a) X

5. A projeção ortográfica de um ponto em um plano de projeção é um ponto idêntico.

6.

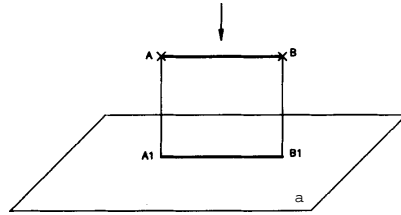

7. b) X

8. b) X

9. F

10. c) X

Aula 7

1. **Coluna II** (c) (a) () (b)

2. a) de cima b) planohorizontal c) vista superior

3. V 4. b) X

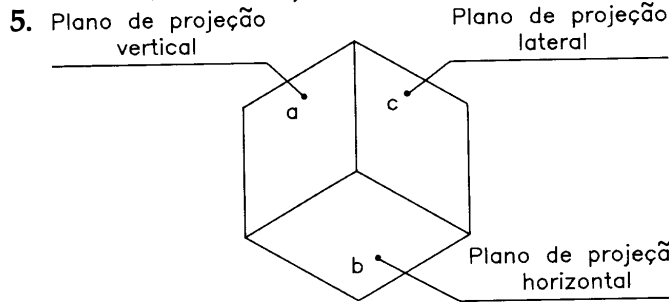

6. **Coluna I**

plano de projeção horizontal

plano de projeção vertical

plano de projeção lateral

Coluna II

- de lado
- de frente
- de cima
- de baixo

7. **Vertical.**

8.

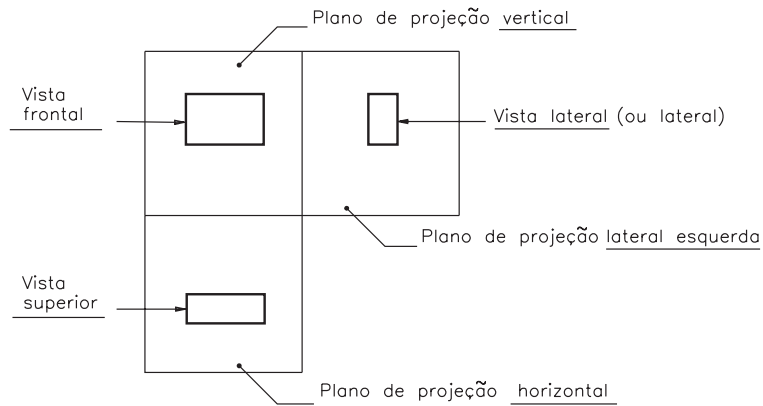

9. b) X

10. a) X

11. c) X

12. a) Vista lateral esquerda.

12.b)



13.a) X

14.b) X

Aula 8

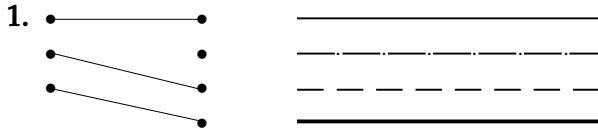

2. a) Relacionar.

3. a) Linha para arestas e contornos visíveis. b) Linha para arestas e contornos **não** visíveis. c) Linha projetante auxiliar.

4. b) X

5. c) X

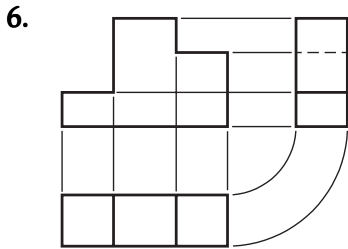

7. Vista frontal.

8. c) X

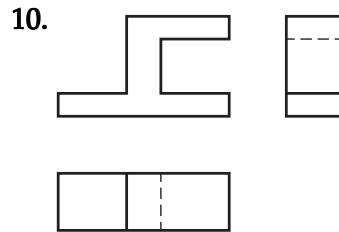
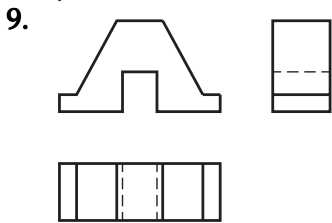

11.c) X

12.b) X

Aula 9

1. b) X c) X

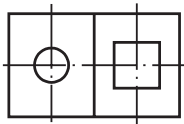
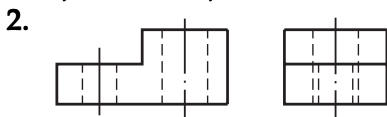

3. F

4. a) sim X b) não X

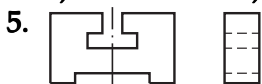

6. b) X d) X

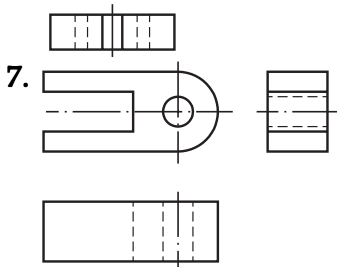

Aula 10

1.

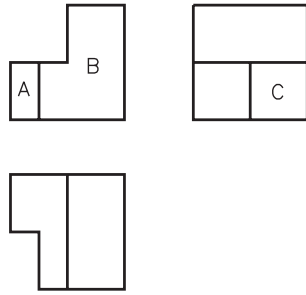

2.

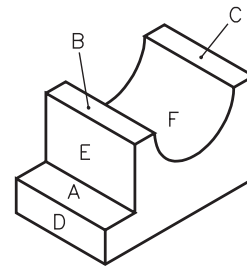

3.

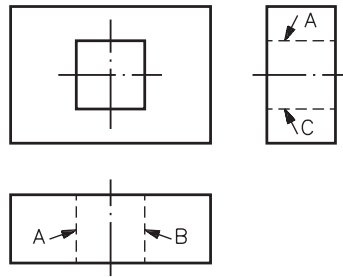

4.

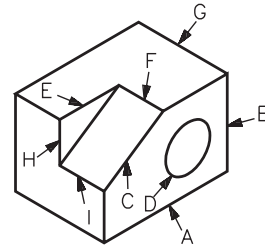

5.

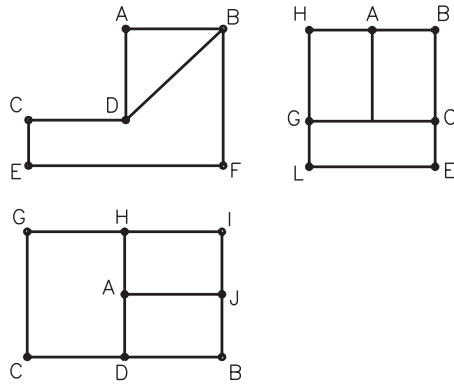

6.

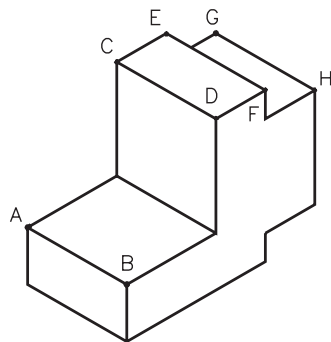

7.

a)

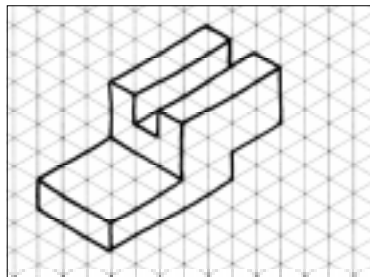

b)

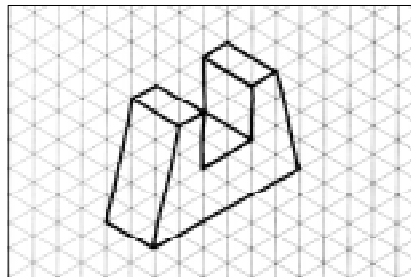

c)

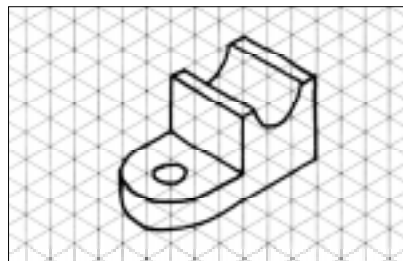

8.

a)

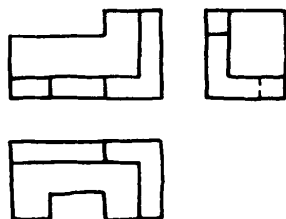

b)

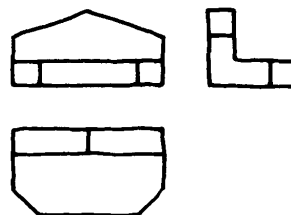

c)

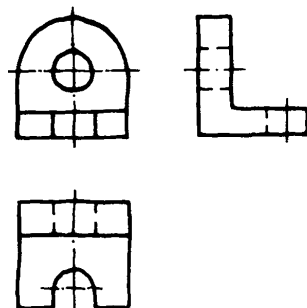

Bibliografia

- ABNT/SENAI-SP. **Coletânea de normas de desenho técnico**, 1990.
- BACHMANN, Albert & FORBERG, Richard. **Desenho técnico**. Editora Globo, 1976.
- BEZERRA, Manoel Jairo et alii. **Geometria 1**. MEC. FENAME, 1988.
- CUNHA, Luis Veiga da. **Desenho Técnico**. Fundação Calouste Gulbenkian, Lisboa, 1989.
- FRENCH, Thomas E. & VIERCK, Charles J. **Desenho técnico e tecnologia gráfica**. Rio de Janeiro. Editora Globo, 1985.
- MACHADO, Ardevan. **Geometria descritiva**. Editora McGraw Hill do Brasil, 1979.
- MACHADO, Ardevan. **Perspectiva**. Pini Editora, 1988.
- MAGUIRE, D. & SIMMONS, C. **Desenho técnico**. Hemus Editora, 1982.
- MANFÉ, Giovanni et alii. **Desenho técnico mecânico: curso completo**. Editora Hemus, 1977. 3 v.
- SCHNEIDER, W. **Desenho técnico: introdução aos fundamentos do desenho técnico**. Editora Jácomo, 1978.
- SENAI-SP. **Leitura e interpretação de desenho técnico mecânico**. DTE, 1982.
- SOUZA, Aécio Batista de, et alii. **Desenho Mecânico**. MEC, 1975.

