

Project Ideas

Using RapMan





Project Ideas

Additional project ideas.

The RapMan is very versatile and without doubt teachers and students will very quickly be thinking up their own project ideas. But here are a few starters.

RapMan need not only be limited to Product Design, RMT, or Engineering. Why not see if you can cross over to include projects for Food Technology or Textiles.

Product Design

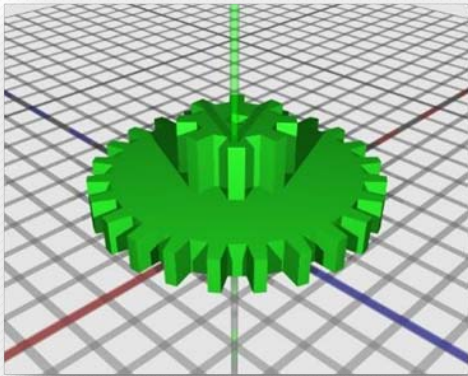

Gears

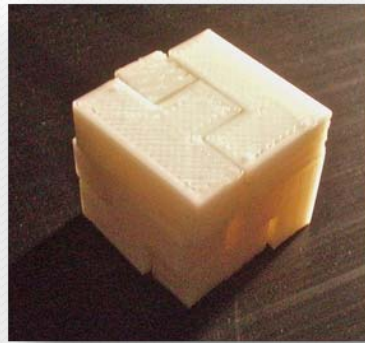

Puzzles



Containers

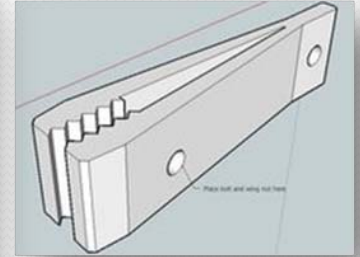

Clips



Product models

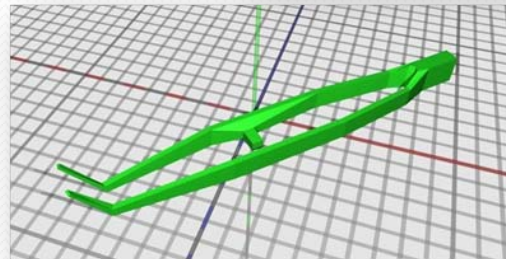

Tweezers

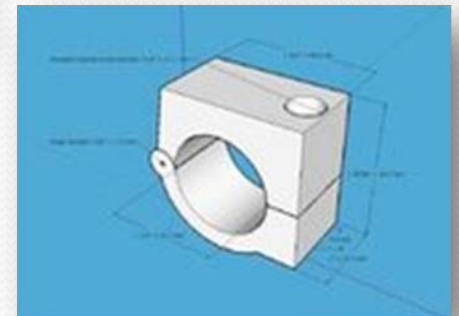

Food Technology



Measuring spoons



Spatulas

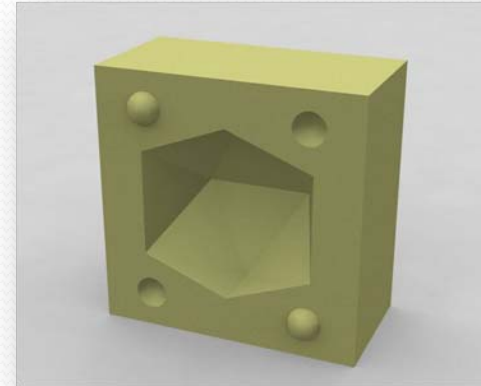

Chocolate moulds

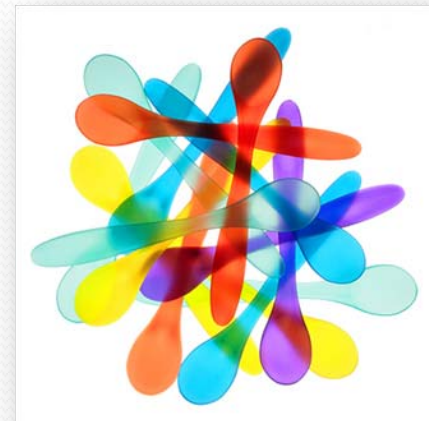

Picnic cutlery

Textiles Technology



Hair clips



Bracelets



Shaped buttons



Buckles

Thingiverse

- Need even more ideas?

Try “Thingiverse” a place to share digital designs that can be made into real, physical objects.

www.thingiverse.com

RapMan

- RapMan is a low cost 3D printer available from Bits from Bytes www.bitsfrombytes.com
- Further assistance can be found on the BfB forum and wiki.

Forum

<http://www.bitsfrombytes.com/fora/user/index.php>

Wiki <http://www.bitsfrombytes.com/wiki>