

# 2PL-2.4G

Frequency Hopping Spread Spectrum



**2PL-2.4G**  
2-channel, FHSS  
Radio control system  
for Car

## INSTRUCTION MANUAL

1M23N12413

**Futaba**® Digital Proportional R/C System

Thank you for purchasing a Futaba FHSS 2PL 2.4GHz system.

This system is based on the combination of the newly developed 2.4GHz transmitter and its correspondent receiver. Before using your 2PL 2.4GHz system, read this manual carefully and use your R/C set safely.

After reading this manual, store it in a safe place.

### **FHSS 2PL 2.4GHz system**

- 2.4GHzSS (Spread Spectrum) radio communication system
- Frequency channel setting unnecessary: Sifting the channels within the 2.4GHz band automatically, this system minimizes the interference from other 2.4GHz system.
- Accepts no unwanted signals by using ID code
- Built-in antenna (T2PL-2.4G transmitter)

### **Application, Export, and Modification**

1. This product may be used for models only. It is not intended for use in any application other than the control of models for hobby and recreational purposes.

2. Exportation precautions:

(a) When this product is exported from the country of manufacture, its use is to be approved by the laws governing the country of destination which govern devices that emit radio frequencies. If this product is then re-exported to other countries, it may be subject to restrictions on such export. Prior approval of the appropriate government authorities may be required. If you have purchased this product from an exporter outside your country, and not the authorized Futaba distributor in your country, please contact the seller immediately to determine if such export regulations have been met.

(b) Use of this product with other than models may be restricted by Export and Trade Control Regulations, and an application for export approval must be submitted.

3. Modification, adjustment, and replacement of parts: Futaba is not responsible for unauthorized modification, adjustment, and replacement of parts on this product. Any such changes may void the warranty.

### **Compliance Information Statement (for U.S.A.)**

This device, trade name Futaba Corporation of America, model number R603GF, complies with part 15 of the FCC Rules. Operation is subject to the following two conditions:

- (1) This device may not cause harmful interference, and
- (2) This device must accept any interference received, including interference that may cause undesired operation.

The responsible party of this device compliance is;

3002 N Apollo Drive Suite 1, Champaign, IL 61822 U.S.A.

TEL (217)398-8970 or E-mail: [support@futaba-rc.com](mailto:support@futaba-rc.com) (Support)

TEL (217)398-0007 or E-mail: [service@futaba-rc.com](mailto:service@futaba-rc.com) (Service)

### **Battery Recycling (for U.S.A.)**



The RBRC™ SEAL on the (easily removable) nickel-cadmium battery contained in Futaba products indicates that Futaba Corporation of America is voluntarily participating in an industry program to collect and recycle these batteries at the end of their useful lives, when taken out of service within the United States. The RBRC™ program provides a convenient alternative to placing used nickel-cadmium batteries into the trash or municipal waste system, which is illegal in some areas.

You may contact your local recycling center for information on where to return the spent battery. Please call 1-800-8-BATTERY for information on Ni-Cd battery recycling in your area. Futaba Corporation of America's involvement in this program is part of its commitment to protecting our environment and conserving natural resources.

RBRC™ is a trademark of the Rechargeable Battery Recycling Corporation.

# Table of Contents

<b>Safety Precautions .....</b>	<b>4</b>
Definition of Symbols .....	4
2.4GHz System Precautions .....	4
Operation Precautions .....	5
Storage and Disposal Safety Precautions .....	6
Other Safety Precautions .....	7
<b>Before Operation .....</b>	<b>8</b>
System Contents .....	8
Nomenclature / Handling .....	9
<b>Assembly / Adjustment .....</b>	<b>12</b>
Receiver and Servo Connection .....	12
Receiver antenna Installation .....	12
Assembly Precautions .....	13
How to link transmitter and receiver .....	14
Transmitter Set-Up Procedures .....	15
<b>2PL-2.4G Functions .....</b>	<b>16</b>
Steering Trim (TRM-CH1) .....	16
Throttle Trim (TRM-CH2) .....	16
Steering Dual Rates (D/R-CH1) .....	16
Model Selection/Model Reset (MDL) .....	17
Steering Servo Reversing (REV-CH1) .....	17
Throttle Servo Reversing (REV-CH2) .....	17
Steering End Point Adjustment (EPA-CH1) .....	17
Throttle End Point Adjustment (EPA-CH2) .....	18
ABS function (ABS-CH2) .....	18
Model Name (NAME) .....	18
Throttle Fail Safe Function .....	18
MC231CR/MC331CR .....	19
<b>Function Map .....</b>	<b>20</b>
*Each function is easily selected with the SELECT key and set with the digital trim DT1/DT2.	
<b>Reference .....</b>	<b>22</b>
Ratings .....	22
Troubleshooting .....	23
Error Displays .....	24
When Requesting Repair .....	25

**Safety  
Precautions**

**Before  
Operation**

**Assembly /  
Adjustment**

**2PL-2.4G  
Functions**

**Function  
Map**

**Reference**

**Warning:** This product contains a chemical known to cause cancer and birth defects (or other reproductive harm).

- No part of this manual may be reproduced in any form without prior permission.
- The contents of this manual are subject to change without prior notice.
- This manual has been carefully written. Please write to Futaba if you feel that any corrections or clarifications should be made.
- Futaba is not responsible for the use of this product.

# Safety Precautions

For your safety as well as that of others, please read this manual thoroughly prior to installation and operation of your digital proportional R/C system.



## Definition of Symbols

The following defines the symbols used in this manual.

### Explanation of Symbols





<b>⚠ DANGER</b>	Procedures which may lead to a dangerous condition and cause death or serious injury to the user if not carried out properly.
<b>⚠ WARNING</b>	Procedures which may lead to a dangerous condition or cause death or serious injury to the user if not carried out properly, or procedures where the probability of superficial injury or physical damage is high.
<b>⚠ CAUTION</b>	Procedures where the possibility of serious injury to the user is small, but there is a danger of injury, or physical damage, if not carried out properly.

### Explanation of Graphic Symbols

-  Indicates an operation that prompts a warning (including Caution).
-  Indicates an operation that must not be performed.
-  Indicates an operation that always must be performed.

## 2.4GHz System Precautions

### ⚠ WARNING

-  Do not cover/hold the built-in antenna part of T2PL-2.4G transmitter by your hand during running. Do not put any conductive plate/sticker on the antenna part. Otherwise, the operating range may become shorter.
-  Do not perform the linking procedure with motor's main wire is connected or the engine is operating as it may result in serious injury.
-  While the linking is done, please cycle receiver power and check if the receiver to be linked is really under the control by the transmitter to be linked.
-  Always use R603GF under 6.0V NiCd battery or regulated output from ESC. If using dry cell batteries, it may cause malfunction. Be sure that when using ESC's regulated output the capacity of the ESC must meet your usage condition.
-  In order to maintain complete control of your car/boat it is important that it remains visible at all times. Running behind large objects is not suggested. Doing so may result in the reduction of the quality of the radio frequency link to the model.

# Operation Precautions

## WARNING

 When using a Ni-cad battery to power your system, always charge and check the battery voltage prior to operation. Should the battery discharge below the minimum voltage level, control will be lost.

 Prior to operation always perform a range test. Even one abnormality in the R/C system may cause loss of control.

### **[Range Test Procedure]**

Have a friend hold the model, or place on a stand where the wheels or prop can not come in contact with any object. Operate from a distance of about 100 feet. Be sure to check the movement of each servo to make sure it follows the movement of the steering wheel and throttle trigger. If the servos do not follow the commands from the transmitter or any type of interference is detected, Do Not operate the model.

 Never operate in the rain or run through puddles. The transmitter, receiver, batteries and most servos, and speed controls are not waterproof. Contact with any type of moisture or immersion in water or snow will cause damage along with possible loss of control. Should any type of moisture enter any component of the system, immediately stop using the R/C system and return it to our service center for inspection.

 Do not operate when visibility is limited. Should you lose sight of the model, a collision or other dangerous situation may occur.

 Do not operate near people or roads. Do not operate on any pond when boats are present. Do not operate near high tension power lines or communication broadcasting antennas. Prior to the operation of any model be sure the area you plan to use is safe. Be aware of all objects that may be in the path of your model. Do not operate the model where people or any type of moveable object could stray in the path of your model. Control loss due to interference, component failure, loss of sight or low battery voltage could result in serious injury to yourself and others as well as damage to your model.

 Do not operate when you are tired, not feeling well or under the influence of alcohol or drugs. Your judgment is impaired and could result in a dangerous situation that may cause serious injury to yourself and others.

 **(Turning on the power switches)**  
Always check the throttle trigger on the transmitter to be sure it is at the neutral position.  
1. Turn on the transmitter power switch.  
2. Turn on the receiver or speed control power switch.

### **(Turning off the power switches)**

Always be sure the engine is not running or the motor is stopped.  
1. Turn off the receiver or speed control power switch.  
2. Then turn off the transmitter power switch.

If the power switches are turned off in the opposite order the model may unexpectedly run out of control and cause a very dangerous situation.

---

 Make all adjustments to the radio control system with engine not running, or the electric motor disconnected.  
If the engine is running or the motor is connected while adjustments are made, the model may run out of control.

---

 Remove the main battery source from electric powered models when they are not being used.  
Should you accidentally leave the receiver switch on, the model could run out of control.

---

 **(Fail safe function)**  
Before running (cruising), check the fail safe function.

**Check Method:**

Before starting the engine, check the fail safe function as follows:

1. Turn on the transmitter and receiver power switches.
  2. Turn off the transmitter power switch.
  3. Check if the fail safe function moves the servos to the preset position when reception fails.
- The fail safe function is a safety feature that minimizes set damage by moving the servos to a preset position when reception fails. However, if set to a dangerous position, it has the opposite effect.

**Setting example:** Throttle idle or brake position

---

## CAUTION

 Do not touch the engine, motor, speed control or any part of the model that will generate heat while running.  
Touching hot parts will result in serious burns.

---

 When the charger is not in use, disconnect it from the outlet. This will prevent accidents, overheating and short circuits.

## Storage and Disposal Safety Precautions

---

### WARNING

 At the end of a day's operation, store the system with NiCd battery discharged. Be sure to recharge the system before it is used again.  
You should fully discharge your system's batteries periodically to prevent a condition called "memory". For example, if you only make two runs in a day or you regularly use a small amount of battery's capacity, the memory effect can reduce the actual capacity even if the battery is charged for the recommended amount of time.

---

 Do not throw a Ni-cad battery into a fire. Do not disassemble or attempt to repair a Ni-cad battery pack.  
Overheating, damage and acid leakage may lead to burns, loss of eye sight as well as numerous other types of injuries. The electrolyte in Ni-cad batteries is a strong alkali. Should you get even the smallest amount of the electrolyte in your eyes, Do Not rub, wash immediately with water, and seek medical attention at once. The electrolyte can cause blindness. If electrolyte comes in contact with your skin or clothes, wash with water immediately.

---

 Do not leave the radio system or models within the reach of small children.  
A small child may accidentally operate the system. This could cause a dangerous situation

---

and injuries. NiCd batteries can be very dangerous when mishandled and cause chemical damage.

## **⚠ CAUTION**

**⊘** Do not store your R/C system where it will be exposed to the following conditions.

- Extreme heat or coldness
- Exposed to direct sunlight
- Where humidity is high
- Where vibration is prevalent
- Where dust is prevalent
- Where there is steam and condensation

Storing your R/C system under adverse conditions could cause deformation and numerous other problems with operation.

**!** If the system will not be used for a long period of time, remove the batteries from the model and store in a cool, dry place.  
If the batteries are left in the model, electrolyte may leak and damage the model.

### **<NiCd Battery Recycling>**

A used NiCd battery is valuable resource. Insulate the battery terminals and dispose of the battery by taking it to a battery recycling center.

## **Other Safety Precautions**

### **⚠ CAUTION**

**!** When operating two or more models at the same time, have a third person act as a spotter. They will be in charge of safety and you should follow their instructions.

**!** Beginners should receive instructions regarding safety and operation from an experienced modeler.

**!** Always use only genuine Futaba transmitter, receivers, servos, and electronic speed controls, along with other optional parts and components.  
Futaba will not be held responsible for damages caused by other than genuine Futaba parts and components. Use only genuine Futaba parts and components listed in the instruction manual and catalog.

**⊘** Do not short circuit the Ni-cad battery terminals.  
Short circuiting the terminals will lead to sparks and overheating and could cause a fire and burns as well.

**⊘** Do not expose plastic parts to fuel, motor spray, waste oil or exhaust.  
The fuel, motor spray, waste oil and exhaust will penetrate and damage the plastic.

### **<NiCd Battery Electrolyte>**

The electrolyte in NiCd batteries is a strong alkali. Should you get even the smallest amount of the electrolyte in your eyes, DO NOT RUB. Wash immediately with water and seek medical attention at once. The electrolyte can cause blindness. If electrolyte comes in contact with your skin or clothes, wash with water immediately.

# Before Operation

## System Contents

After opening the container, check the contents for the following items. The contents will vary with the system purchased.

2PL-2.4GHz System Contents				
Transmitter	T2PL-2.4G (x1)			
Receiver	R603GF (x1)			
Servo	-----	S3003 (x2)	S3003 (x1)	S3050 (x1)
E.S.C.	-----	-----	MC230CR or MC330CR (x1)	MC330CR (x1)
Switch	SSW-GS (x1)		-----	-----
Miscellaneous	Mini Screwdriver *Servo mounting hardware and servo horns (only w/servo set)			

**NOTE:** Futaba FHSS system, T2PL-2.4G transmitter and R603GF receiver, does not work with current Futaba FASST system. Please use T2PL-2.4G and R603GF in pairs. Futaba FASST system and FHSS system are not compatible each other.

## Receiver R603GF

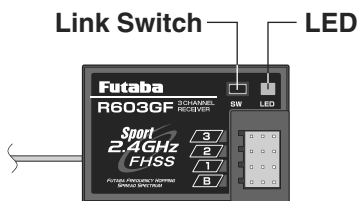

### Connectors

- "3" : (No function)
- "2" : Throttle Servo (CH2)
- "1" : Steering Servo (CH1)
- "B": Power connector

## Servo S3003/S3050

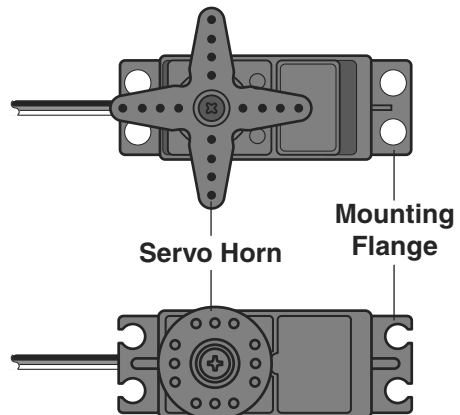



# Nomenclature / Handling

## Transmitter T2PL-2.4G

### ⚠ WARNING

❗ As with all radio frequency transmissions, the strongest area of signal transmission is from the sides of the antenna(built-in). As such, the antenna(arrow direction) should not be pointed directly at the model.



<sup>(\*)</sup>

#### **Digital trim DT1, DT2, and D/R operation**

Push the lever to the left or right (up or down).

The current position is displayed on the LCD screen for about two seconds. Each step is indicated by a tone. When the trim exceeds the maximum trim adjustment range, the beep tone will change and the servo will not move any further. Remember, the trims are digital so the position of each trim is remembered for each model separately.

### ⚠ WARNING



Do not cover/hold the built-in antenna part of T2PL-2.4G transmitter by your hand during running.

Do not put any conductive plate/sticker on the antenna part.

Otherwise, the operating range may become shorter.

## Battery Replacement Method

### (4 AA size batteries)

- 1 Remove the battery cover from the transmitter by sliding it in the direction of the arrow in the figure.
- 2 Remove the used batteries.
- 3 Load the new AA size batteries. Pay very close attention to the polarity markings and reinsert accordingly.
- 4 Slide the battery cover back onto the case.

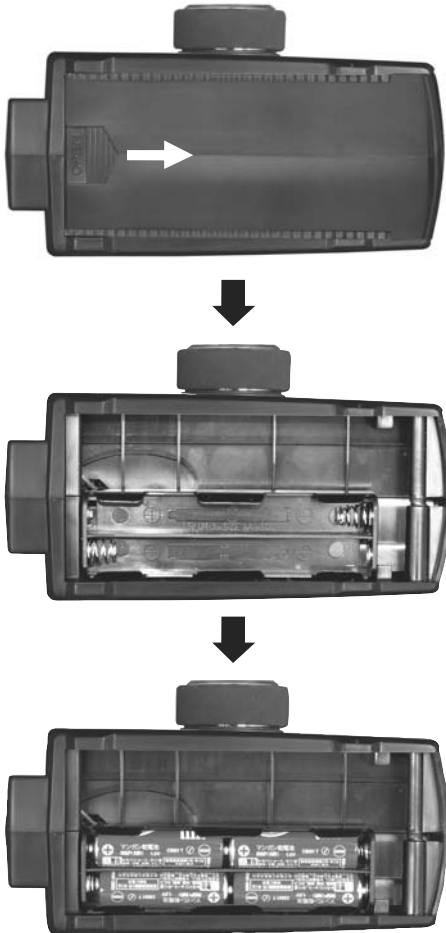

## ⚠ CAUTION

- ! Always be sure you reinsert the batteries in the correct polarity order. If the batteries are loaded incorrectly, the transmitter may be damaged.
- ! When the transmitter will not be used for any short or long period of time, always remove the batteries. If the batteries do happen to leak, clean the battery case and contacts thoroughly. Make sure the contacts are free of corrosion.

### Check:

Turn the power switch on the transmitter to the ON position. Check the battery voltage display on the LCD screen. If the voltage is low, check the batteries for insufficient contact in the case or incorrect battery polarity.

### Low Battery Alarm:

If the transmitter battery voltage drops below 4.2V an alarm will sound and "LOW" will be displayed on the LCD screen.



The low battery alarm is meant to be a safety feature only. Do NOT operate your radio below 4.5V. Always shut your radio off as soon as possible after the low battery warning tone to avoid loss of control.

# E.S.C. MC230CR / MC330CR

## Applicable motors (Number of turns is criteria.)

- Use the MC230CR with a motor with 20T or more turns.
- Use the MC330CR with a motor with 13T or more turns.

\*If a motor with a number of turns smaller than the above is used, the heat protector and overcurrent protection circuit may operate. The number of turns of the motor is a criteria only. Depending on the running conditions, the protection circuit may operate even if the condition above is satisfied.

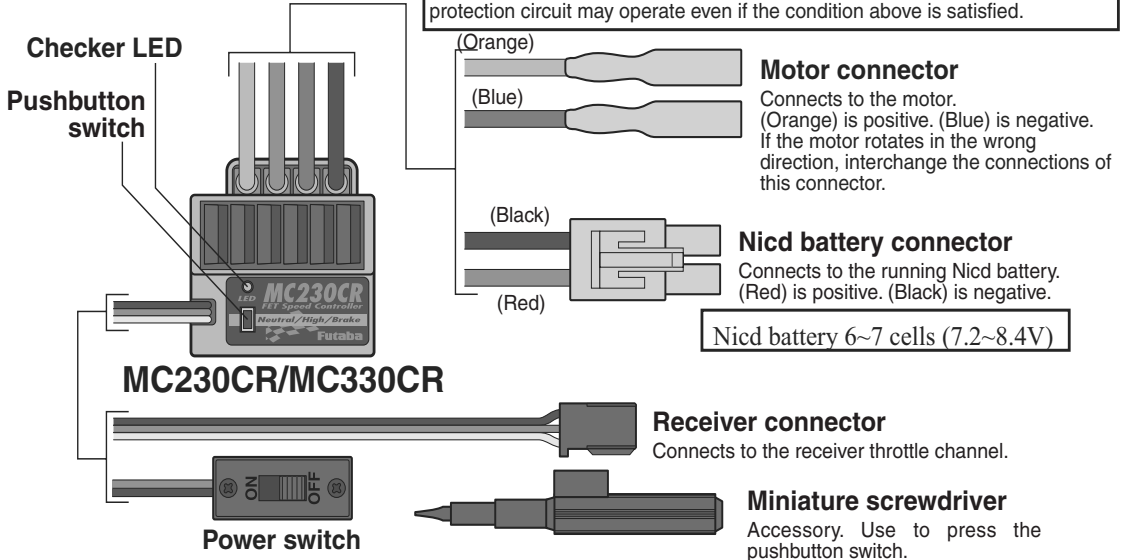

## Receiver and Servo Connection

As you connect the receiver, servos and other components, do so in accordance with the "Assembly Precautions".

Connections when a E.S.C. MC230CR or MC330CR are used.

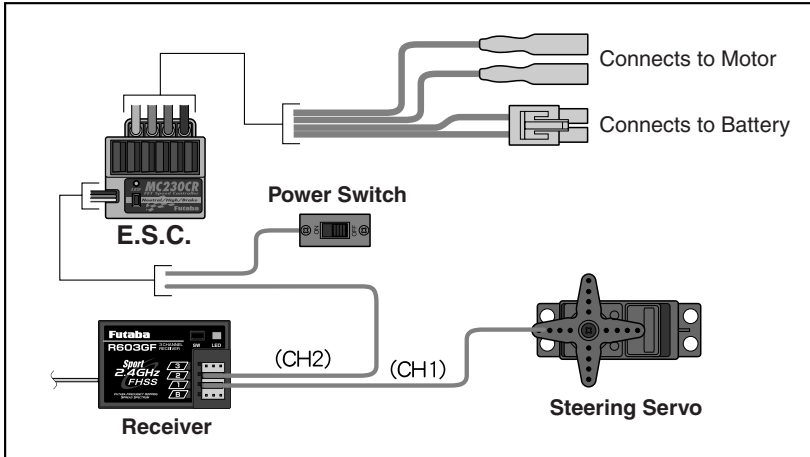

Gas Powered Model

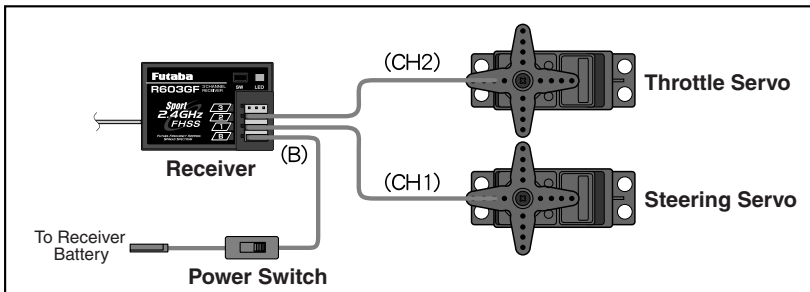

## Receiver Antenna Installation

Install the R603GF receiver on the car as follows:

**Note:** The operating range may become shorter, depending on where the receiver and the antenna are mounted.

### ⚠ WARNING

❗ Install the antenna in the higher place as shown in the figure. Keep the antenna as far away from the motor, ESC and other noise sources as possible. Put the antenna in the antenna tube to protect it.

🚫 Do not cut the antenna. Do not bend the coaxial cable. Doing so causes damage.

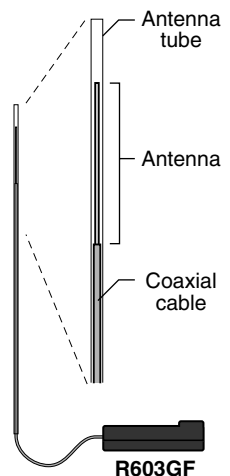

# Assembly Precautions

## **⚠️ WARNING**

**!** Check the receiver, servos, and battery connectors, to be sure they are firmly connected. If a connector is not fully inserted, vibration may cause the connector to work loose while the model is operating. This will result in loss of control.

**!** Operate each servo horn over its full stroke and check to see that the linkage does not bind or is not too loose. Excessive force applied to the servo horn by binding or poor installation may lead to servo problems and result in loss of control.

**!** **(Electric Cars and Boats)**  
Isolate the receiver from vibration by attaching to the chassis or mounting plate with thick double sided tape.

**(Gas Powered Cars and Boats)**

Isolate the receiver from vibration by wrapping it in foam rubber or similar type cushioning material. Protect the unit from water damage by placing it in a plastic bag or waterproof radio box.

The receiver contains precision electronic parts. These parts are vulnerable to vibration and shock. Any contact with moisture (water or condensation) may cause receiver malfunction and loss of control.

**!** Keep all devices that omit high frequency noise, such as motors, batteries, and wiring that handles heavy current loads, at least 1/2 inch away from the receiver and the receiver antenna. High frequency noise will cause a decrease in operating range and could cause loss of control.

**!** Install electronic speed control heat sinks as well as other components that conduct electricity so they can not come in contact with aluminum, carbon fiber or other materials that conduct electricity. If, for example, the speed control came loose while the model was running and touched an aluminum chassis, a short circuit may occur that would cause irreparable damage to the system as well as loss of control.

**!** Noise suppression capacitors should be installed on almost all motors. If the proper capacitors are not installed, high frequency noise will reduce range and cause loss of control along with various other problems.

**!** Inspect all linkage installations and any point where metal could come in contact with other metal parts. Make sure these parts do not touch other metal parts under vibration. Should a linkage or other metal parts come in contact with other metal parts under vibration, the high frequency noise generated by this contact will cause interference and possible loss of control.

## **⚠️ CAUTION**

**⊘** Do Not disassemble any part of this system that is not specified in the instruction manual. Futaba will not be responsible for any damage due to improper disassembly of any part of the radio control system.

## How to link the transmitter and the receiver

Each transmitter has an individually assigned, unique ID code. In order to start operation, the receiver must be linked with the ID code of the transmitter with which it is being paired. Once the link is made, the ID code is stored in the receiver and no further linking is necessary unless the receiver needs to be used with an other transmitter. (For T/R set, the link is already done at factory.)

### Link procedure

- 1 Bring the transmitter and the receiver close to each other, within one meter.
- 2 Turn on the transmitter and the receiver.
- 3 Push and hold the Link Switch of the receiver.
- 4 When the link is complete, the LED in the receiver changes to solid green.

\*Please refer the table below for LED status vs receiver's condition.

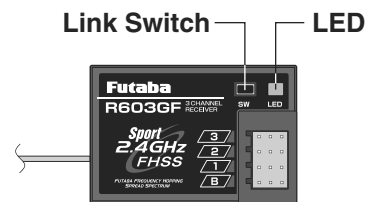

### LED status vs receiver's condition:

No signal reception	<b>Red : On</b>
Receiving signals	<b>Green: On</b>
Receiving signals, but ID is unmatched.	<b>Green: Blink</b>

# Transmitter Set-Up Procedures

\*When making these settings adjustments, do so with the motor disconnected or the engine not running.

## (Preparations)

Select the model memory that is not used and reset it to the initial values with the model selection and model reset functions.

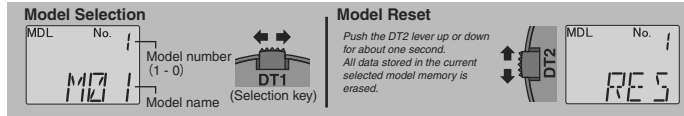

## Servo Horn Installation Instructions

**1** Connect the receiver, servos, and other components and then turn on the power switches to transmitter and receiver.

\*Both servos will move to the neutral position.

**2** At this time install the servo horn in the manner described in the instruction manual provided with the model this system will be used in.

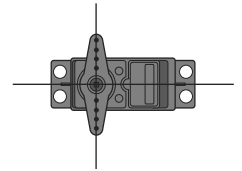

## Reversing The Servo Operation Direction

Should the servo operate in the opposite direction required for your application, reverse the direction with the servo reversing.

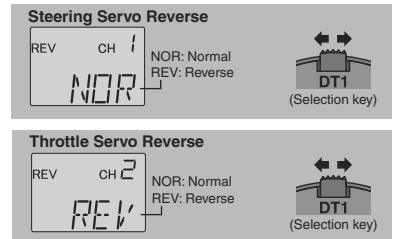

## E.S.C. MC230CR / MC330CR

### NEUTRAL, HIGH, AND BRAKE MAX POINTS SETTINGS

#### ⚠ CAUTION

① Set the steering angle adjustment function (ATV) to 100% and the ABS function and acceleration function to OFF using the transmitter throttle channel function.

If the steering angle is too large or the ABS and acceleration functions are on, erroneous operation may occur.

\*When using the ABS function, after setting up the MC230CR / MC330CR, stop the reverse function, then turn on the ABS function. If the ABS function is on, the MC231CR / MC331CR cannot be set up correctly.

Before setting each point, set the transmitter throttle channel trim to neutral.

**1** Turn on the power in transmitter -> amp order.

	Transmitter throttle operation	MC230CR / MC330CR (Pushbutton switch operation)	MC230CR / MC330CR (Checker LED)
<b>2</b> Neutral point setting	Neutral state	• Press the pushbutton switch. (0.5 secs or longer) (Confirmation beep sounds)	• Continuous single blink 
<b>3</b> High point setting	Full High state	• Press the pushbutton switch. (Confirmation beep sounds)	• Continuous double blink 
<b>4</b> Brake MAX point setting	Full brake state	• Press the pushbutton switch. (Confirmation beep sounds.)	• If the LED goes out, setting is complete. 

\* Since the data is read at the end of setting of all points, the points cannot be set independently.  
\* If the amp power was turned off during setting, the setting points cannot be memorized. (The previous settings are retained.)  
\* The confirmation beep sounds only when the motor was connected.

If the LED does not go off but blinks rapidly, setting was not performed normally. Repeat setting from "Neutral point setting".  
• Continuous rapid blink

## Steering Trim (TRM-CH1)

Steering neutral adjustments can be made by moving the Steering trim knob to the left or right.

### Racers Tip

When you install a servo, always check to be sure the servo is at its neutral position. Adjust the servo horn hole position and linkage so both are parallel. When a servo saver is used, place it as close to center position as possible. Be sure the steering trim on the transmitter is at the neutral position.

### Trim Operation And Maximum Travel

Changing the trim can affect the overall settings. When adjustments are made with the trims, recheck your installation for maximum travel. (Steering EPA right side and left side).

### When Trim usage is extreme

If it takes most of your trim movement to get a servo to the neutral position, reposition the servo horn or servo saver on the servo and inspect your linkage installation.

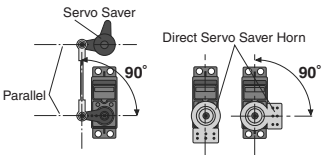
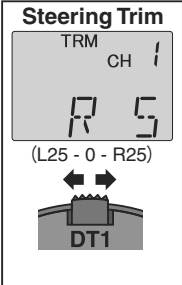

## Throttle Trim (TRM-CH2)

Throttle neutral adjustments can be made moving the throttle trim to the left or right.

### Racers Tip

When using an electronic speed control, set the throttle trim to neutral and make adjustments to the speed control. On a gas powered model, set the trim to neutral and adjust the linkage to the point where the carburetor is fully closed in accordance with the engine instruction manual.

### Trim Operation and Travel

Trim adjustments will affect the overall servo travel. Check the brake side (backward) movement when changes are made.

### When trim movement is extreme

If you use most of the trim movement to get the servo to the neutral position, recenter the servo horn closer to the neutral position and inspect your throttle linkage.

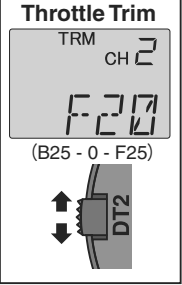

Carburetor Fully Closed

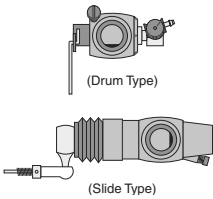

## Steering Dual Rates (D/R-CH1)

Use this function to adjust the steering travel of your model. If the model understeers (push) while cornering, add steering by pressing the upper side of the D/R button. When the model oversteers (loose), take away steering by pressing the lower side of the D/R button.

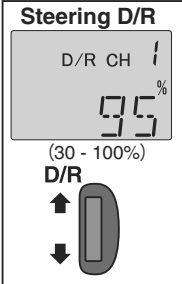



## Model Selection/Model Reset (MDL)

The model selection selects the desired model memory from the 10 model memories stored within the transmitter and the model reset erases all data stored in a specific model memory.

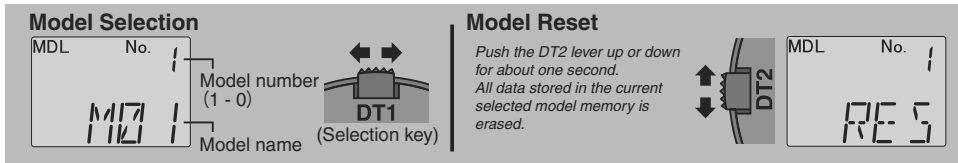

## Steering Servo Reversing (REV-CH1)

This function reverses the rotation direction of the Steering servo.

When the trim position deviates from the center, the deviation will be on the opposite side when the servo is reversed.

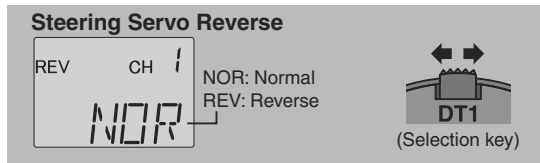

## Throttle Servo Reversing (REV-CH2)

This function reverses the rotation direction of the throttle servo.

When the trim position deviates from the center, the deviation will be on the opposite side when the servo is reversed.

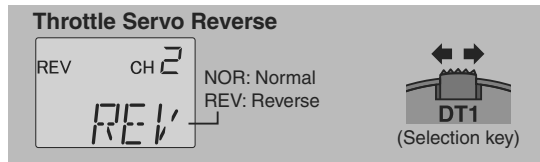

## Steering End Point Adjustment (EPA-CH1)

Use this function to limit the servo movement to the left or right. The servo travel to each side can be independently adjusted. This feature will compensate for any difference in right or left turning angles or radius due to the characteristics of your model.

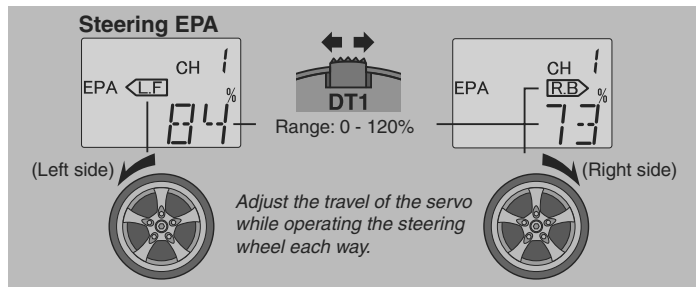

### **⚠ WARNING**



Be sure that the steering linkage does not bind or come in contact with any suspension parts or arms. If unreasonable force is applied to the servo, the servo may be damaged and result in loss of control.

## Throttle End Point Adjustment (EPA-CH2)

This function is used to adjust the forward and brake side servo travel. Each direction can be adjusted independent of each other. Use this feature to set the throttle servo travel.

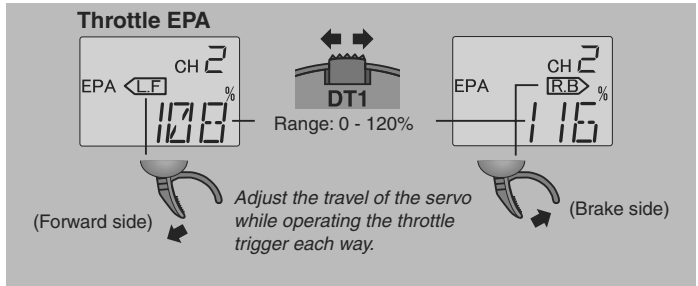

### ⚠ WARNING



Be sure that your throttle linkage does not apply excessive force to the servo. If your linkage installation causes an unreasonable amount of force to be applied to the servo, the servo may be damaged and result in loss of control.

## ABS function (ABS-CH2)

This function simulates a full size car's antilock braking by pulsing the brake on and off rapidly. Model stops as rapidly as possible without skidding.

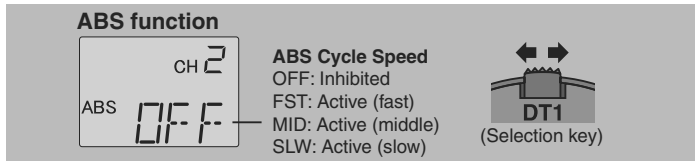

- The cycle speed can be selected from FST/MID/SLW.

## Model Name (NAME)

This function provides a 3-character name for each of the model memories in the transmitter to easily select the correct setup for the model currently in use.

- Clearly label each model for easy selection.

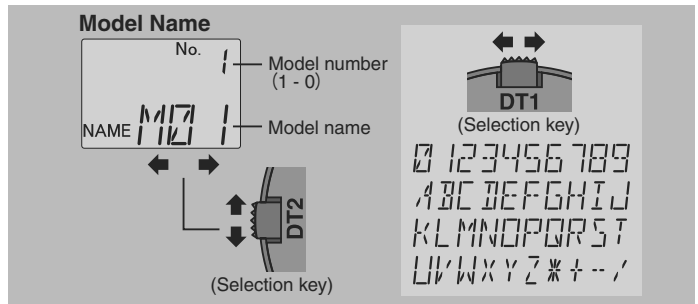

## Throttle Fail Safe Function

This function moves the throttle servo to a preset position when the receiver cannot receive the signal from the transmitter for some reason.

When the signal from the transmitter can be received again, this function automatically resets.

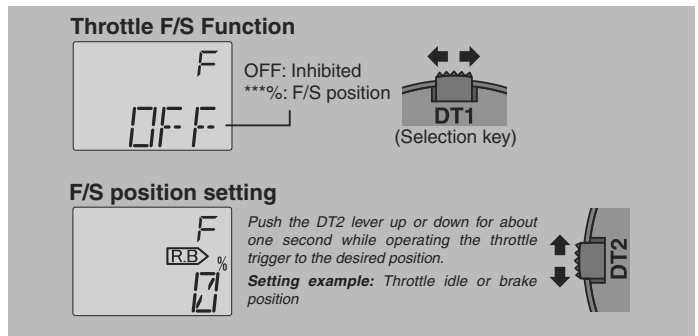

- \*For gasoline engine cars, it is recommended that the fail safe position be set to the direction that applies the brakes.

# MC230CR/MC330CR

## CANCELLING THE REVERSE FUNCTION

The amp reverse function can be cancelled by the following method so that the model can be used even in races that prohibit reverse running. (Brake operation only)

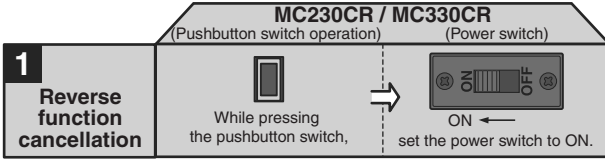

\* When desired, you can enable the cancelled reverse function by repeating the operation shown at the left. (The reverse function is switched alternately.)

## BRAKE/REVERSE OPERATING INSTRUCTIONS

Operation can be switched to reverse operation by returning the throttle trigger (or throttle stick) from the brake position to the neutral position.

## PROTECTION CIRCUIT OPERATION

The following protection circuits are built into the MC230CR / MC330CR. When a protection circuit operates, remove the cause before operating the model again.

<b>Overcurrent protection</b>	When an overcurrent flows due to an output short circuit, etc., the overcurrent protection circuit automatically limits the current to protect the FET. ⇒ Remove the cause of the short circuit, etc. before operating the model again.
<b>Heat protector</b>	When abnormal heating of the FET due to an overload, etc. is detected, the heat protector operates so that the speed is gradually reduced. ⇒ When the FET temperature drops, the heat protector automatically resets. However, remove the cause of the overheating before operating the model again.
<b>Low voltage operation</b>	When the Nicd battery voltage drops, this function limits the motor output current and ensures steering operation. ⇒ After the speed drops, immediately recover the vehicle.

## CHECKER LED DISPLAY

The amp operates linearly in proportion to the amount of forward, reverse, and brake operation. The amp operating state can be checked with the checker LED as shown below.

Operation	Checker LED display
<b>Amp power ON</b>	<p>(Reverse operation set) Single blink (Single confirmation beep)</p> <p>(Only brake operation set) Double blink (Two confirmation beeps)</p>
<p><b>High point</b></p> <p>Forward</p>	<p>Off</p> <p>On *Becomes brighter nearer the high point.</p>
<p><b>Neutral point</b></p>	Off
<p><b>Brake MAX point</b></p>	<p>On *Becomes brighter nearer the brake MAX point.</p> <p>Off</p>
<p><b>(Amp power left on alarm)</b> When the transmitter power was turned off first.</p>	<p>Blinks. (Confirmation beep also sounds.)</p> <p>*Not used with PCM receivers. *When the transmitter is OFF, this function is not performed in environments such that the servo operates erroneously. Not sure what this is supposed to mean in yellow.</p>

\* Confirmation beep only sounds when the motor was connected.

# Function Map

Power switch turned on



The current model name is displayed for about two seconds.

(Initial Screen)



### Digital trim DT1, DT2, and D/R display

The current position is displayed on the LCD screen for about two seconds when each digital trim is operated.

<p><b>Steering Trim</b></p> <p>TRM CH 1</p> <p>R 5</p> <p>(L25 - 0 - R25)</p> <p>DT1</p>	<p><b>Throttle Trim</b></p> <p>TRM CH 2</p> <p>F 20</p> <p>(B25 - 0 - F25)</p> <p>DT2</p>	<p><b>Steering D/R</b></p> <p>D/R CH 1</p> <p>95%</p> <p>(30 - 100%)</p> <p>D/R</p>
--	---	---



- Press the select button to select the desired function screen.
- Press it for about two seconds to return to the initial screen.

<p><b>Model Selection</b></p> <p>MDL No. 1</p> <p>M07</p> <p>Model number (1 - 0)</p> <p>Model name</p> <p>(Selection key)</p>	<p><b>Model Reset</b></p> <p>Push the DT2 lever up or down for about one second. All data stored in the current selected model memory is erased.</p>
<p><b>Steering Servo Reverse</b></p> <p>REV CH 1</p> <p>NOR</p> <p>NOR: Normal REV: Reverse</p> <p>(Selection key)</p>	<p>• DT1 and DT2 operate only as the data input keys in the programming mode. These do not operate as the trim levers.</p>
<p><b>Throttle Servo Reverse</b></p> <p>REV CH 2</p> <p>REV</p> <p>NOR: Normal REV: Reverse</p> <p>(Selection key)</p>	

• DT1 and DT2 operate only as the data input keys in the programming mode. These do not operate as the trim levers.



### Steering EPA

(Left side) Adjust the travel of the servo while operating the steering wheel each way. (Right side)



### Throttle EPA

(Forward side) Adjust the travel of the servo while operating the throttle trigger each way. (Brake side)



### ABS function

**ABS Cycle Speed**  
 OFF: Inhibited  
 FST: Active (fast)  
 MID: Active (middle)  
 SLW: Active (slow)

(Selection key)



### Model Name

No. 1 — Model number (1 - 0)  
 NAME M171 — Model name

(Selection key)

(Selection key)

0 1 2 3 4 5 6 7 8 9  
 A B C D E F G H I J  
 K L M N O P Q R S T  
 U V W X Y Z \* + - /



### Throttle F/S Function

OFF: Inhibited  
 \*\*\*%: F/S position

(Selection key)

### F/S position setting

(Selection key)

Push the DT2 lever up or down for about one second while operating the throttle trigger to the desired position.  
**Setting example:** Throttle idle or brake position

To Initial Screen

\*Specifications and ratings are subject to change without prior notice.

## Ratings

### Communication method:

One-way operation system

### Maximum operating range:

80m (Optimum condition)

### For safety:

F/S (Throttle), ID (About 4 billion ways of pair identifications)

---

### Transmitter T2PL-2.4G

(FHSS system, wheel type, 2 channels)

#### Transmitting frequency:

2.4GHz band

#### Power requirement:

(Dry cell battery) Penlight x 4(6V)

#### Current drain:

100mA or less

#### Transmission antenna:

1/2λ di-pole (Built-in)

---

### Receiver R603GF:

(FHSS system, 3 channels)

#### Power requirement:

4.8V or 6V NiCd battery

#### Size:

26x39x10mm (excluding a projection part)

#### Weight:

8g

---

### Servo S3003

(Standard servo)

#### Power requirement:

6V (common with receiver)

#### Current drain:

8mA (at 6V / Idle)

#### Output torque:

4.1kg-cm (57in.-oz.) at 6V

#### Operating speed:

0.19sec/60 degree at 6V

#### Size:

40.4x19.8x36mm (1.59x0.78x1.42in.)

#### Weight:

37.2g (1.31oz.)

---

### Servo S3050

(Standard digital servo)

#### Power requirement:

6V (common with receiver)

#### Current drain:

8mA (at 6V / Idle)

#### Output torque:

6.5kg-cm (90.3oz.-in.) at 6V

#### Operating speed:

0.16sec/60 degree at 6V

#### Size:

40.0x20.0x38.1mm (1.57x0.79x1.50in.)

#### Weight:

49g (1.72oz.)

---

### E.S.C. MC230CR / MC330CR

(Electronic speed control)

#### Operating system:

Forward, reverse, and brake operations are all linear.

#### Power requirement:

Nicd battery 6-7 cells (7.2 to 8.4V)

#### PWM frequency:

1.5kHz (fixed)

#### Setting:

One-touch input by pushbutton switch. Set data is saved to built-in EEPROM.

#### Current capacity (FET rating):

Forward=90A/200A, reverse=45A/100A

#### Size:

27.1x33.3x12.8mm (1.07x1.31x0.50in.)  
(excluding protruding parts)

#### Silicon cord gauge size:

AWG16/AWG14 equivalent

#### Weight:

44/45g (1.55/1.59oz.)

(including connectors and switches)

#### BEC voltage:

6.0V

**NOTE:** Futaba FHSS system, T2PL-2.4G transmitter and R603GF receiver, does not work with current Futaba FASST system. Please use T2PL-2.4G and R603GF in pairs. Futaba FASST system and FHSS system are not compatible each other.

# Troubleshooting

If your system fails to operate or you experience a short range problem or erratic control, check the table below for possible causes. If after you have followed the suggestions listed the problem is not corrected, return the system to our service department for inspection and repair.

## (Item Check)

### Transmitter

#### Battery

- Dead battery → Change the batteries.
- Batteries inserted incorrectly. → Reload the batteries in accordance with the polarity markings
- Faulty contact → Check to see if the contacts are bent and not making good contact
- Dirty contacts → Clean the contacts and check for corrosion.

### Receiver

#### Battery

- Dead battery → Replace or recharge
- Wrong polarity → Check connections

#### Antenna

- Near other wiring → Move away from wiring
- Was antenna cut → Request repair
- Is the antenna installed correctly → Refer to the receiver installation.

#### Monitor LED

- Check the LED of the receiver.
- Refer to the "How to link the transmitter and the receiver".

### Connector connections

- Wiring incorrect → Insert all connectors firmly
- Loose connections → Push the connector in firmly

### Linkage

- Binding or loose → Adjust the linkage in model
- Is movement stiff → Adjust linkage in model

### Motor (Electric powered)

- Noise problems → Install capacitors on motor

## Error Displays

### Low Battery Alarm

If the transmitter battery voltage drops to 4.2V or less, an audible alarm will sound and "LOW v" will be displayed on the LCD screen.

#### LCD screen:



#### **⚠ WARNING**



When a low battery alarm is generated, cease operation immediately and retrieve the model. If the battery goes dead while in operation, you will lose control.

### Backup Error

If the data is lost for an unknown reason, an audible alarm will sound and "ERR" will be displayed on the LCD screen.

#### LCD screen:



#### **⚠ WARNING**



When a backup error is generated, immediately stop using the system and request repair from the Futaba Service Center. If you continue to use the system, the transmitter may malfunction and cause loss of control.

### RF Error

If the RF circuit is failed for an unknown reason, an audible alarm will sound and "RF" will be displayed on the LCD screen. Please request repair from the Futaba Service Center

#### LCD screen:

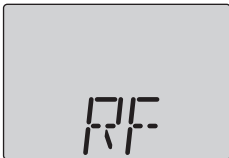



## When requesting repair

Before requesting repair, read this instruction again and recheck your system. Should the problems continue, request as follows.

### (Information needed for repair)

Describe the problem in as much detail as possible and send the letter along with the system in question.

- Symptom (Including the conditions and when the problem occurred)
- R/C System (Send transmitter, receiver and servos)
- Model (Type of model, brand name and model number or kit name)
- Detailed packing list (Make a list of all items sent in for repair)
- Your name, address and telephone number.

### (Warranty)

Read the Warranty card.

- When requesting warranty service, send the card or some type of dated proof of purchase.

### Hobby Services (U.S. only)

3002 N. Apollo Drive, Suite 1

Champaign, IL 61822 U.S.A.

Phone: (217) 398-0007

[www.hobbyservices.com](http://www.hobbyservices.com)

---

FUTABA CORPORATION

Makuhari Techno Garden Bldg., B6F 1-3 Nakase, Mihama-ku, Chiba 261-8555, Japan  
Phone: (043) 296-5119 Facsimile: (043) 296-5124

©FUTABA CORPORATION 2009, 06 (1)

# 2PL-2.4G

Frequency Hopping Spread Spectrum

**Futaba®**